

ATTEN



GT-6200/ GT-6150 User Manual

SHENZHEN ATTEN TECHNOLOGY CO., LTD

Contents



Copyright information.....	2
Description of common icons.....	2
Essential knowledge for users.....	2
Safety precautions.....	2
Disclaimer.....	2
Packing list.....	3
Schematic diagram of the whole equipment.....	5
Connection mode for the whole equipment.....	5
Connection steps for the whole equipment.....	6
Technical parameters.....	7
Description of working interface.....	8
Operations of temperature setup.....	10
Quick call the related parameters at certain temperature.....	11
Opening and close of GT-6200 channels.....	12
Parameter setup.....	13
Total items of parameter setup menu of the host system.....	14
Parameter setup menu of the channels for the handle.....	17
Connecting mode of the functional ground wire.....	21
Maintenance.....	22
Product warranty.....	23
After-sales contact.....	23
Appendix.....	24
Product warranty card.....	25

Copyright information

The design of this product (including internal software) and its accessories is under the protection of relevant state-laws. Any violation of the relevant rights of our company will be subject to legal sanctions. Users shall consciously abide by the relevant state laws when using this product.

Description of common icons

Thank you for using our products. Before using the product, please read this manual carefully and pay attention to the relevant warnings and cautions mentioned in this manual.

 Warning	Misuse of this product may lead to serious injury or death to the user.
 Caution	Misuse of this product may lead to serious injury to the user or material damage to the object involved.

Essential knowledge for users

Users are required to have basic knowledge of common sense and electrical operations before using the product. Minors shall use the product under the guidance of a professional or guardian.

[Caution]:To avoid damaging the equipment and keep the safety of the operational environment,please read this manual carefully and keep it well so that you may read it anytime when necessary.

Safety precautions

To avoid electric shock or injury to the human body or fire hazard,the following basic rules must be observed when using the equipment.In order to ensure personal safety,only parts and accessories approved or recommended by the original factory canbe used,otherwise serious consequences may occur!

WARNING

When using this product, the soldering pencil/soldering tip, with the temperature up to 150-480 C , may cause burns to the user or cause a fire due to improper application.

So Users shall strictly observe the following rules:

- Keep this product away from flammable materials.
- Keep the product out of children's reach.
- Do not use this product if you are inexperienced or have no sufficient necessary knowledge without the guidance of related personnel.
- Do not use this product under wet environment or with wet hands to avoid electric shock.
- Do not modify this product and its accessories without authorization.
- Please turn off the power when replacing parts and iron tips, and not resume the use until the equipment is completely cooled down.
- Please use the accessories from the original factory When replacing the product parts.
- Make sure to turn off the power switch when the equipment is temporarily stopped or out of use.

WARNING

- To ensure the normal operation of this product's ESD function,only three-core power cord shall be used as the host connectingline.
- Smoke will be generated during the soldering operations. So please pay attention to the smoke evacuation.
- Do not play or do other similar dangerous actions during using this equipment, because it can easily lead to injury to others or yourself.
- Do not use this product for purposes other than soldering.
- Do not modify this product and accessories, otherwise the original warranty will be invalidated or damage may occur to the product.
- When plugging and unplugging the power cord and handle plug, please hold the plug body and do not pull the cord.
- Do not hit the product or its accessories too hard during the operation, otherwise damage may occur to the product.

Disclaimer

We will take no responsibility for any personal injury or property damage caused by reasons other than the product quality problem, which may include force majeure (natural disasters,etc.) or personal behavior during the operation of this product. This manual is organized, compiled and released by SHENZHEN ATTEN TECHNOLOGY CO.,LTD. according to the latest product features. We will not responsible for further notice of the subsequent improvement of the product and this Manual.

Packing list



GT-6200 host



GT-6150 host



Manual



3.5mm grounding receptacle



Power cord



Certificate of qualification

GT-6200 packing list		GT-6150 packing list	
GT-6200 host	1	GT-6150 host	1
Operation manual	1	Operation manual	1
Power cord	1	Power cord	1
Certificate of qualification	1	Certificate of qualification	1
3.5mm grounding receptacle	1	3.5mm grounding receptacle	1

GT-6150 optional combo

Standard packing

GT-Y130
(applicable to conventional soldering occasion)

Combo A

GT-Y150
(applicable to lead-free high-power soldering occasion)

Combo B

GT-Y050 (applicable to precision soldering occasion)

Combo C

GT-N100 (applicable to precision soldering occasion)

GT-6200 optional combo

Standard packing



+



Combo A



+



Combo B



+



Combo C



+



Combo D



+



Combo E



+



Combo F



+



Combo G



+



Schematic diagram of the whole equipment

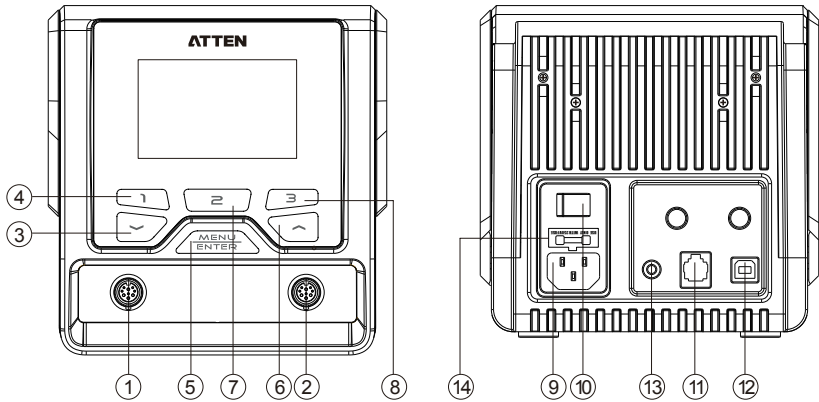

- ① Interface for the soldering tool channel 1
- ② Interface for the soldering tool channel 2(GT-6150 is not equipped with such interface)
- ③ Down arrow key /minus key
- ④ Rapid temperature key 1, Close key of the Interface for the soldering tool channel 1,
- ⑤ Setup menu switch key of the Interface for the soldering tool channel 1
- ⑥ "Confirm" key, Menu key Up arrow key /minus key
- ⑦ Rapid temperature key 2, System setup menu switch key
- ⑧ Rapid temperature key 3, Close key of the Interface for the soldering tool channel 2, Setup menu switch key of the Interface for the soldering tool channel 2
- ⑨ Power supply public seat, access rated ac power
- ⑩ Power master switch
- ⑪ RS232 Communication interface
- ⑫ USB Communication interface (This function is not available yet.)
- ⑬ Functional grounding interface
- ⑭ Supply fuses

Connection mode for the whole equipment

1 Connection mode for the whole equipment- GT-6200

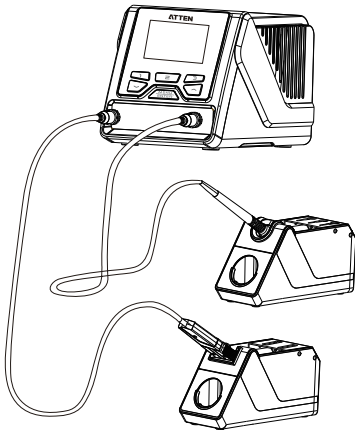

2 Connection mode for the whole equipment-GT-6150

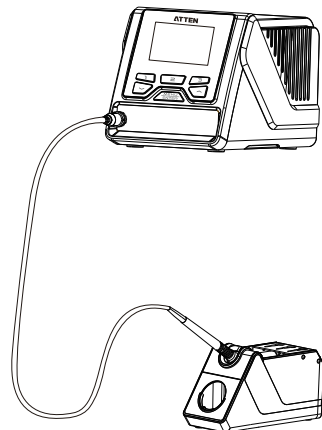

Connection steps for the whole equipment

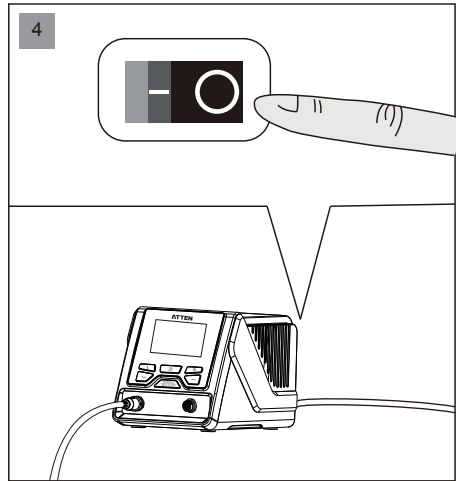
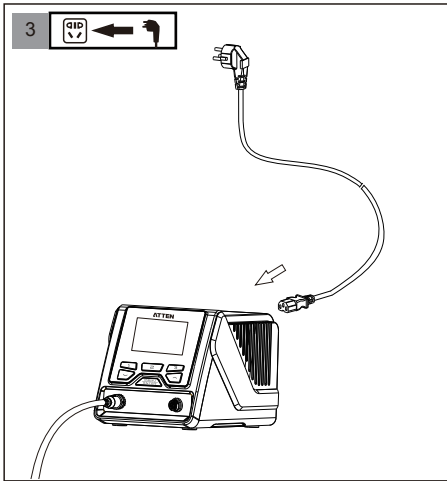
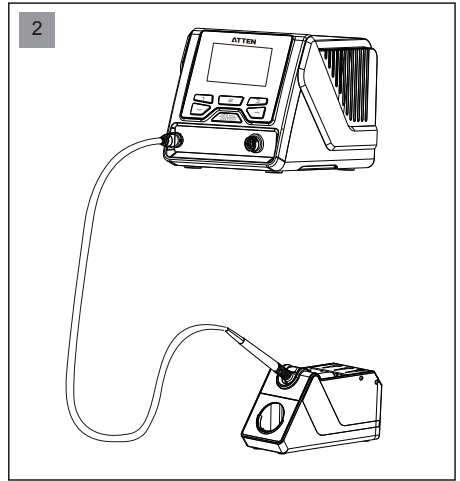
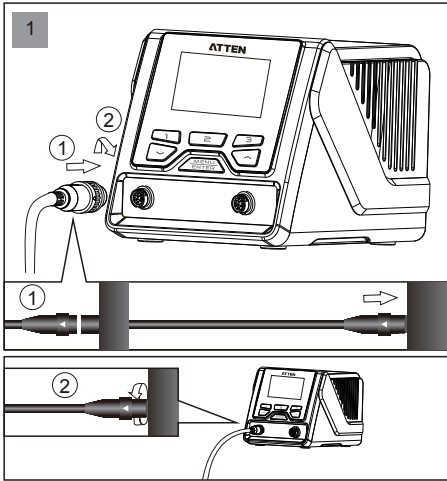

Note

To avoid the damage to the host, do not forget to turn off the power when inserting the plug into or removing the plug from the soldering tools!

Technical parameters

Product No	GT-6200	GT-6150
Rated working voltage	AC 230V±10% 50Hz (110V±10% 60Hz)	
Rated power	200W	150W
Security Level	Class 1(Host of the controller)Class 3(Accessories of soldering handle)	
Power fuse	T 2.5A (230V AC) T 3.15A (110V AC)	T 2.5A (230V AC) T 3.15A (110V AC)
Temperature range	150 C ~ 480 C / 302 F ~ 896 F (Configurable temperature range depends on the connected accessories of the soldering handle)	
Temperature accuracy	±8 C / ±15 F	
Temperature stability	±2 C / ±4 F	
Number of tool channels	Channel 2(can be connected with 2 soldering handles simultaneously)	Channel 1
Functional ground connection	3.5mm plug(which is hard grounding when not connected, is directly connected to the protective ground wire)	
Temperature adjustment step	Long press to adjust 10 units at a time, short press to adjust 1 unit at a time	
Standby mode	0~120 minutes, the default time is 0 minutes, turn off Standby mode	
Dormancy mode	0~120 minutes, the default time is 0 minutes, turn off Dormancy mode	
Rapid temperature	3 groups of temperature, which can be called quickly.	
Display resolution	240x160 Dots(white letters on blue)	
System language	English/Chinese	
Communication address range	1~255 (not open yet)	
Working conditions	Temperature 0 C ~ 40 C Relative humidity < 80%	
Storage conditions	Temperature -20 C ~ 80 C Relative humidity < 80%	
Dimension	315 (L) × 252 (W) × 127 (H) mm	
Weight	Approximately 4kg	

Description of working interface

Description of GT-6200 working interface

After connected with charger.Turn-on the power switch.The product will be working normally after the screen display.System verion for 3 seconds.

GT-6200 startup interface



GT-6200 normal working interface

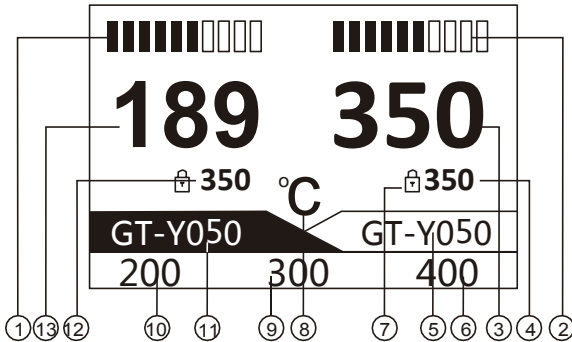

- ① Status display area of channel 1, display power bar / product working status / abnormal code.
- ② Status display area of channel 2, display power bar / product working status / abnormal code.
- ③ Actual temperature display area of channel 2, display of the indicative description of abnormal work conditions.
- ④ Set temperature display area of channel 2.
- ⑤ Soldering tool model display area of channel 2.
- ⑥ Channel 1/Channel 2 rapid temperature 3.
- ⑦ Fixed temperature icon display.
- ⑧ System temperature unit display area.
- ⑨ Channel 1/Channel 2 rapid temperature 2.
- ⑩ Channel 1/Channel 2 rapid temperature 1.
- ⑪ Soldering tool model display area of channel 1.
- ⑫ Set temperature display area of channel 1
- ⑬ Actual temperature display area of channel 1, display of the indicative description of abnormal work conditions.

Description of GT-6150 working interface

After connected with charger. Turn-on the power switch. The product will be working normally after the screen display. System verion for 3 seconds.

GT-6150 start up interface



GT-6150 normal working interface

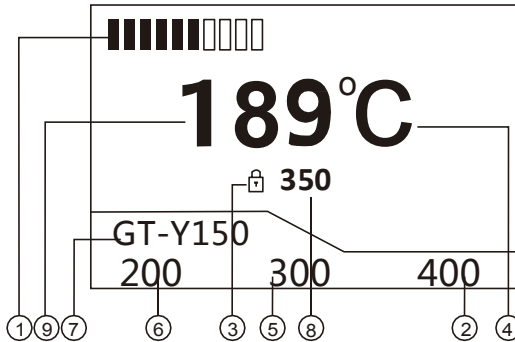

- ① Status display area of channel 1, display power bar / product working status / abnormal code.
- ② Channel 1 rapid temperature 3.
- ③ Fixed temperature icon display.
- ④ System temperature unit display area.
- ⑤ Channel 1 rapid temperature 2.
- ⑥ Channel 1 rapid temperature 1.
- ⑦ Soldering tool model display area of channel 1.
- ⑧ Set temperature display area of channel 1
- ⑨ Actual temperature display area of channel 1, display of the indicative description of abnormal work conditions.

Operations of temperature setup

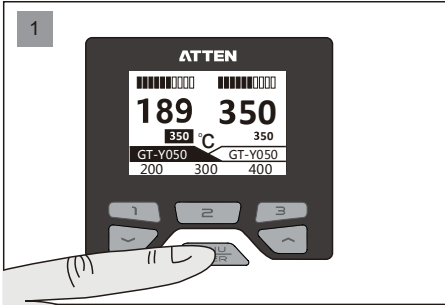

- 1 Short press the "MENU" key to select the channel that needs to be configured. (GT-6150 is not equipped with such channel.)

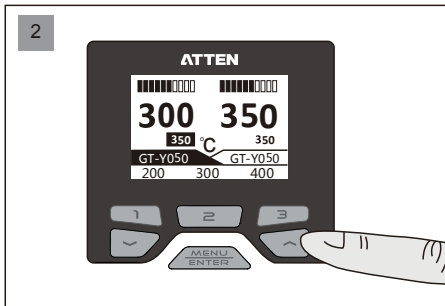

- 2 Press "UP" arrow key to increase the temperature.

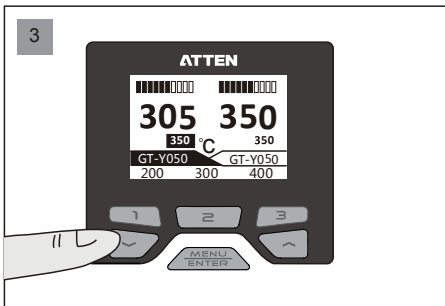

- 3 Press "DOWN" arrow key to decrease the temperature.

Quick call the related parameters at certain temperature

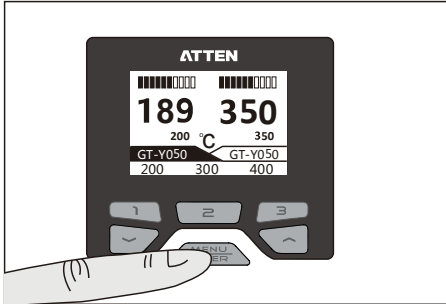

Short press the "MENU" key to select the tool channel 1 or tool channel 2.(not available for GT-6150.)

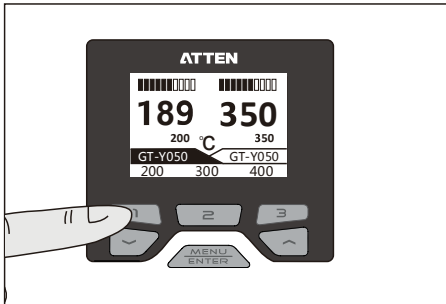

Short press the "1" key to quickly call the set value at 200 C.

Note: Rapid temperature value can be changed and configured in the channel menu.

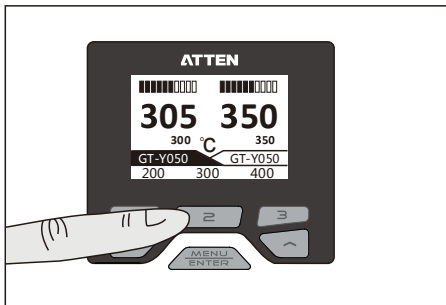

Short press the "2" key to quickly call the set value at 300 C.

Likely, short press the "3" key to quickly call the set value at 400 C.

Opening and close of GT-6200 channels

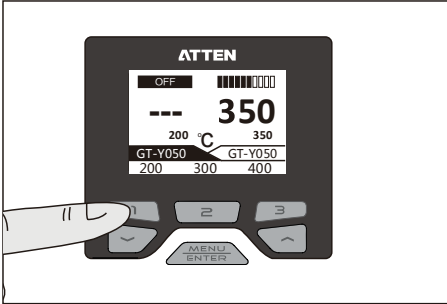

Long press "1" key to open or close channel 1.

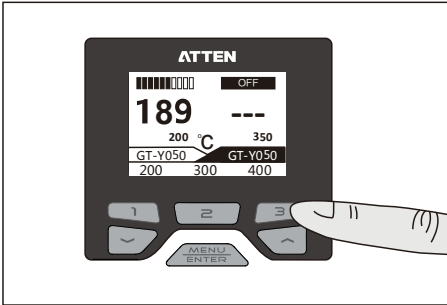

Long press "3" key to open or close channel 2.

Parameter setup

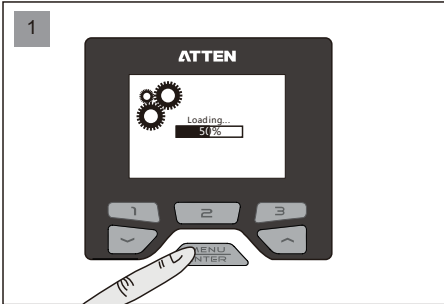

Hold "MENU" key until the load is completed (100%).

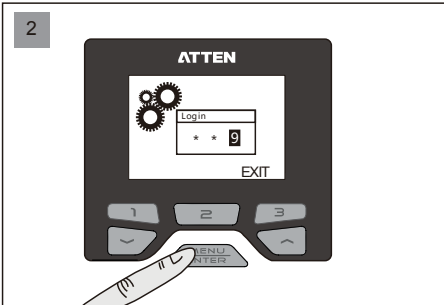

If the configuration page is under the protection of password, the login to "Confirm" page shall be authorized. Press "▲" or "▼" key to change the input value, press "Enter" key to complete one input, press the Rapid temperature key "3", Press the "Logout" key to return to the main interface.

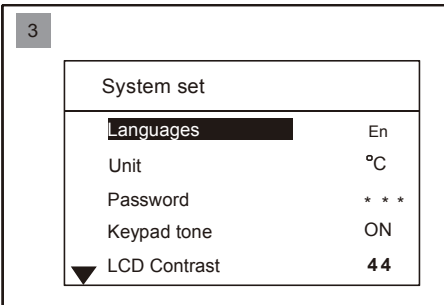

If there is no password protection, or after the correct password is entered, it will jump to the System Parameter setup interface. At this time, the system parameters can be configured.

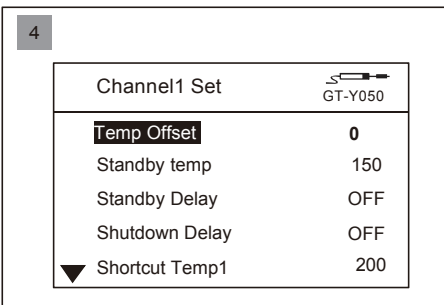

Enter the channel settings page, where the correct handle corresponding to the channel shall be connect.

In the System setup screen, use the '1' key and the '3' key to select the channel to enter.

Note: '1' key corresponds to channel 1, Button '3' corresponds to channel 2.

(GT-6150 products can only select channel 1.)

Note:

Do not change or insert the handle of the welding tool while setting the channel parameters to avoid damaging the welding accessories and the Host.

Total items of parameter setup menu of the host system

System Set	
Languages	En
Unit	°C
Password	* * *
Keypad Tone	ON
▼ LCD Contrast	44

- Languages: Language displayed on the system menu.
- Unit: Temperature unit displayed on the system.
- Password: The authorization password to enter the system parameters interface.
- Keypad Tone: The switch to turn on and off the key operate tone.
- LCD Contrast: Contrast ratio adjustment displayed on the screen.

System setup	
▲ Mode	Nor
Net Address	1
Factory Default	ON
Exit	

- Mode: Used to define the Host communication.
- Net Address: Local communication address defined during networking operation.
- Factory Default: Resume the Host to the factory settings.
- Exit: Press to return to the main interface.

Host system setup parameters

Languages

System Set > Languages

System Set	
Languages	En
Unit	°C
Password	* * *
Keypad Tone	ON
▼ LCD Contrast	44

Used to set the system Language:

EN: English.

CN: Chinese. The factory fault is:English.

Unit

System Set > Unit

System Set	
Languages	En
Unit	°C
Password	* * *
Keypad Tone	ON
▼ LCD Contrast	44

Used to set the system temperature unit:

C: Celsius.

F: Fahrenheit. The factory default is: C.

System Set	
Languages	En
Unit	°C
Password	***
Keypad Tone	ON
▼ LCD Contrast	44

1. Used to lock the system so as to protect the system settings parameters from being changed by any unauthorized personnel.
 2. Work with the fixed temperature under the Parameter setup of the channels for the handle to carry out lockup operation on the whole equipment for welding process control.
- The factory default mode: OFF.

Set PIN code	Locked
	PIN Code : 000

When the system is under the password setting state, enter the three new Password, close the prompt window 3S after the system displays the "Locked" prompt. Press the "Enter" key to return to the Password setting item.

Set PIN code	Message
	PIN code Error

With correct password, the system will be unlocked and the password will be cleared;
 With wrong password, the system will send "wrong password" prompt;

System Set	
Languages	En
Unit	°C
Password	***
Keypad Tone	ON
▼ LCD Contrast	44

Used to turn on and off the key operation tone:
 ON: There is a prompt tone when the button is pressed.
 OFF: There is no prompt tone when the button is pressed.
 The factory default is: ON.

System Set	
Languages	En
Unit	°C
Password	***
Keypad Tone	ON
▼ LCD Contrast	44

Used to set the contrast ratio of the display:
 10: The minimum contrast ratio.
 100: The maximum contrast ratio.
 The factory default is: 44.

System Set	
▲ Unit	°C
Password	* * *
Keypad Tone	ON
LCD Contrast	44
▼ Mode	Nor

Used to set the product's communication mode:

Normal: Turn off the communication function.

Host / Slave: Used for function expansion.

The factory default is: Normal.(this function is not open yet)

System Set	
▲ Password	* * *
Keypad Tone	ON
LCD Contrast	44
Mode	Nor
▼ Net Address	1

Used for the communication between multiple equipment, connecting up to 255 equipment.

Adjustment range: 1 ~ 255 (used for function expansion).

The factory default: 1.(this function is not open yet)

System Set	
▲ Keypad Tone	ON
LCD Contrast	44
Mode	Nor
Net Address	1
▼ Factory Default	

Used to resume the system setup parameters and channel parameters to factory default settings.

After clicking the "State as delivered" key, all the system setup parameters and channel parameters will be resumed to the factory default settings.

Note: This is only applied to those parameters corresponding to the model of the connected handle. If the handle is not connected with the host, the State as delivered function will be not available.

System Set	
▲ LCD Contrast	44
Mode	Nor
Net Address	1
Factory Default	ON
Exit	

Reset and operate this dialog box: press "▲" or "▼" to choose the function and press "Enter" key to perform the function.

Reset	
Factory default?	
NO	YES

Exit

System Set > Exit

System Set	
▲ LCD Contrast	44
Mode	Nor
Net Address	1
Factory Default	
Exit	

Click the "Logout" key to return to the main interface.

All changed parameters will be stored after clicking the "Logout" key and the equipment will then work according to the changed parameters.

Under the system setup menu: press "1" to set the parameter of channel 1; press "2" to set the parameter of channel 3

Total items of parameter setup menu of the channels for the handle

Channel1 Set	GT-Y050
Temp Offset	0
Standby Temp	150
Standby Delay	OFF
Shutdown Delay	OFF
Shortcut Temp1	200

- Temp Offset: Used to compensate the error of the temperature output of the handle.
- Standby Temp: The temperature of the handle when the system is under the standby mode.
- Standby Delay: Turn on and off the standby function.
- Shutdown Delay: Turn on and off the dormancy function.
- Shortcut Temp1: Available for users to quickly call the set temperature 1.

Channel1 Set	GT-Y050
Shortcut Temp2	300
Shortcut Temp3	400
Fix Temp	OFF
Temp UL	480
Temp LL	150

- Shortcut Temp2: Available for users to quickly call the set temperature 2.
- Shortcut Temp3: Available for users to quickly call the set temperature 3.
- Fix Temp: After this mode is activated, the output temperature is locked at this set temperature value.
- Temp UL: the highest temperature that the user can configure in the main working interface
- Temp LL: the lowest temperature that the user can configure in the main working interface

Parameter setup menu of the channels for the handle

Temp Offset

Channel1 Set > Temp Offset

Channel1 Set 	
GT-Y050	
Temp Offset	0
Standby Temp	150
Standby Delay	OFF
Shutdown Delay	OFF
Shortcut Temp1	200

Used to compensate the errors of welding pencil temperature output.

Compensation range: -50 °C ~ +50 °C, -90 °F to +90 °F.

When the value is positive, the handle temperature will increase according to the set value; when the value is negative, the handle temperature will decrease according to the set value.

The factory default value is : 0.

When replacing the heating element or the handle, the temperature if not accurate, can be calibrated by changing the following parameter.

Operation is as follows:

1. Set the to-be-calibrated temperature of the handle to a suitable temperature, such as 350 °C / 662 °F.
2. After the temperature is stabilized, use the thermometer to measure the actual temperature of the soldering tip of the current handle, for example, the actual temperature is measured as 365 °C / 689 °F.
3. Through the analysis, it is concluded that the actual current temperature is 15 °C / 27 °F higher than the set temperature.
4. Set the temperature compensation value to -15 °C / -27 °F to compensate the error of the output temperature.

Standby Temp

Channel1 Set > Standby Temp

Channel1 Set 	
GT-Y050	
Temp Offset	0
Standby Temp	150
Standby Delay	OFF
Shutdown Delay	OFF
Shortcut Temp1	200

When the handle is under the standby mode, the maintaining temperature is:

150 °C / 302 °F: the lowest standby temperature.

300 °C / 572 °F: the highest standby temperature value.

When the set actual operating temperature is less than the set standby temperature, the product will enter the standby mode with the actual operating temperature.

The factory default is: 150.

Standby Delay

Channel1 Set > Standby Delay

Channel1 Set 	
GT-Y050	
Temp Offset	0
Standby Temp	150
Standby Delay	OFF
Shutdown Delay	OFF
Shortcut Temp1	200

The product automatically enters into the standby state based on the set delay value (unit: minute) if the handle is idle for a long time:

1 ~ 120: The product's dormancy mode will be activated, and enters into the dormant state based on the stipulation time.

OFF: The handle will not enter into the dormancy state.

When the set actual operating temperature is less than the set standby temperature, the product will enter the standby mode with the actual operating temperature.

The factory default is: OFF.

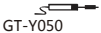
Channel1 Set 	
Temp Offset	0
Standby Temp	150
Standby Delay	OFF
Shutdown Delay	OFF
Shortcut Temp1	200

The product automatically enters into the dormancy state from the standby state based on the set delay value (unit: minute):
 OFF: the product will not enter into the standby state.
 1 ~ 120: The product's dormancy mode will be activated, and enters into the dormant state based on the stipulation time.
 Note: The handle will not enter into the dormancy state if the standby mode is not activated. The factory default is:OFF.

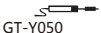
Channel1 Set 	
Temp Offset	0
Standby Temp	150
Standby Delay	OFF
Shutdown Delay	OFF
Shortcut Temp1	200

A total of 3 sets of temperature data are available for users to quickly call subject to the "Temperature lower limit" and "Temperature upper limit".

The factory default value is:

Rapid temperature value 1: 200 C/392 F.

Rapid temperature value 2: 300 C/572 F.

Rapid temperature value 3: 400 C/752 F.

Channel1 Set		 GT-Y050
▲ Shutdown Delay	OFF	
Shortcut Temp1	200	
Shortcut Temp2	300	
Shortcut Temp3	400	
▼ Fix Temp	OFF	

When this mode is on, the handle temperature is locked at this set temperature value.

When the mode is off: temperature lock function is off.

150 ~ 480 °C / 392 ~ 896 °F : The temperature lock function is activated.

The handle is operated according to the fixed temperature value. The user can not adjust the set temperature value in the main interface.

Factory default: OFF.

Channel1 Set		 GT-Y050
▲ Shortcut Temp1	200	
Shortcut Temp2	300	
Shortcut Temp3	400	
Fix Temp	OFF	
▼ Temp UL	450	

The maximum temperature the user can adjust in the main working interface.

The configurable maximum temperature is: 480 °C / 896 °F. The configurable minimum temperature of the "Temperature upper limit" shall be more than the "Temperature lower limit" value.

The factory default value is: 450 °C / 842 °F.

Channel1 Set		 GT-Y050
▲ Shortcut Temp2	300	
Shortcut Temp3	400	
Fix Temp	OFF	
Temp UL	450	
▼ Temp LL	150	

The minimum temperature the user can adjust in the main working interface.

The configurable minimum temperature is: 150 °C / 302 °F. The configurable maximum temperature of the "Temperature lower limit" shall be less than the "Temperature upper limit" value.

The factory default value is: 150 °C / 302 °F.



Channel1 Set		 GT-Y050
▲ Shortcut Temp3	400	
Fix Temp	OFF	
Temp UL	450	
Temp LL	150	
Exit		

Click the "Logout" key to return to the main interface.

All changed parameters will be stored after clicking the "Logout" key and the equipment will then work according to the changed parameters.

Connecting mode of the functional ground wire

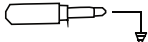
This product uses 3.5mm grounding plug, which is provided with the following four kinds of grounding modes:

1		hard ground	Before the 3.5mm plug is inserted, the ground wire of the soldering tool handle is connected directly to the protective ground wire of the power line.
2		equipotential bonding	After the 3.5mm plug is inserted, the ground wire of the soldering tool handle is connected to the 3 pins of the 3.5mm plug.
3		Floating connection	When the 3.5mm plug is direct connected to the socket instead of being connected to the lead wire, the soldering tool handle is under floating state and unconnected with any ground.
4		Soft ground	When the 3.5mm plug is connected to the ground via 1MΩ or 150KΩ resistor, electrostatic discharge loop is formed.

Schematic diagram of the soldering

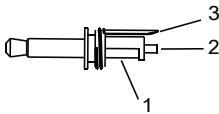

When the equipotential bonding mode is chosen: the ground wire can achieve the related function via being connected to the pin 1, 2, 3.

Maintenance

Fault code or fault description	Likely causes of the faults
E-1: thermal fuse fault	<ol style="list-style-type: none"> 1. In case open circuit fault occurs to the heating core, replace it. 2. In case poor contact occurs to the heating core, unplug and then re-install it. 3. In case the internal connection cable inside the heating core & handle is broken or heating core connection contact piece is damaged, repair the broken lead wire or replace the soldering pencil. 4. In case the lead wire inside the 9PIN pencil is disconnected, repair the broken lead or replace the soldering pencil.
E-2: sensor alarm	<ol style="list-style-type: none"> 1. In case the heating core is damaged, replace it. 2. In case open circuit occurs to the lead wire of the Sensor, check the lead wire of the soldering pencil.
E-3: zero-cross detection abnormal alarm	Should be sent to the designated after-sales service outlet for maintenance.
E-4: abnormal temperature alarm	In case the heating object loses heat too fast, which cannot reach the set specified temperature even being heated for a long time. You need larger power soldering equipment.
E-5: over-current protection	<ol style="list-style-type: none"> 1. Short circuit occurs inside the heating core. 2. In case short circuit occurs to the internal lead wire of the soldering pencil, please replace the soldering pencil.
E-6: abnormal system voltage	<ol style="list-style-type: none"> 1. In case the external power supply voltage is abnormal, please check if the input voltage of the product meets the requirements. 2. In case the host of the product is damaged, please send it to the designated after-sales outlet for maintenance.
E-8: abnormal soldering Tip temperature	<ol style="list-style-type: none"> 1. In case the temperature sensor is abnormal, please replace the heating core. 2. In case the soldering head temperature is too high, please cool the iron head and then restart the equipment.
E-9: abnormal soldering handle status	<ol style="list-style-type: none"> 1. In case the handle is not compatible with this equipment, please replace it with the handle produced by the original factory. 2. In case the internal circuit is abnormal, please send the equipment to the designated after-sales outlet for maintenance.
screen display fault:	<p>In case the problem occurs, you can try to adopt the following measures to solve it. If the problem still cannot be solved, please return the equipment to the original factory for inspection.</p> <ol style="list-style-type: none"> 1. Check if the socket switch is on. 2. Check if there is voltage on the socket. 3. Check if the plug with the power line is loose. 4. Check if the fuse is damaged (if so, please replace the fuse according to the specifications).
inaccurate temperature:	<ol style="list-style-type: none"> 1. Use user temperature compensation function to correct the temperature. 2. Replace the heating core with one produced and sent by the original factory.
Unreadable code:	<ol style="list-style-type: none"> 1. In case there is strong interference source from the outside environment, please change the application environment or evacuate from the interference area. 2. In case the internal circuit is abnormal, please send the equipment to the designated after-sales outlet for maintenance.

Product warranty

- This product is guaranteed for two years from the date of purchase(excluding consumables such as the heating core). If any quality problem is found within the guarantee period, we will response for the maintenance free of charge.
- For those product beyond the warranty period, we provide life-long maintenance services.
- For those product damaged due to users' improper application and unauthorized changes to the product parts, our company only provides limited warranty service.
- In case of a product fault, please send the faulty product to the designated maintenance shop for maintenance, and those service center and personnel unauthorized by the factory are prohibited from carrying out any maintenance on the product.

After-sales contact

After-sales service department Tel: (+86) 755-26976387

Appendix

Exploded view of the equipment

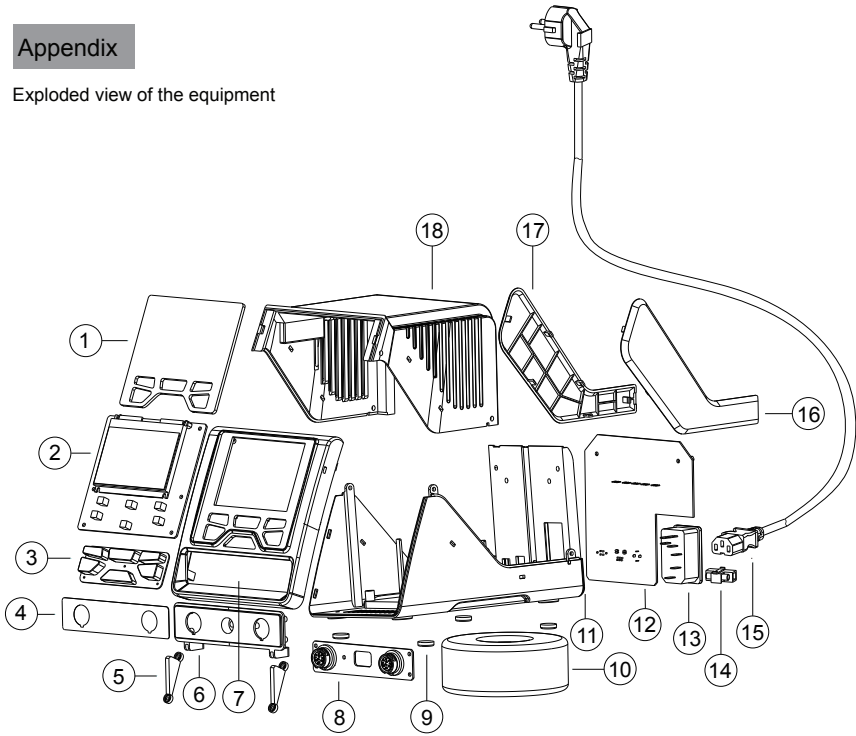

Serial No.	Material name	Serial No.	Material name
1	Display Len	10	Transformer
2	Display Board PCB	11	Bottom shell
3	Silicone key	12	Power board PCB
4	Interface aluminum	13	Public seat
5	Press plate	14	Fuse
6	Interface panel	15	Power cable
7	Panel	16	Right decorative plate
8	Interface board PCB	17	Left decorative plate
9	Self-adhesive foot pad	18	Top shell

Product warranty card

This product is guaranteed for two years from the date of purchase. If any quality problem is found within the guarantee period, we will response for the maintenance free of charge on presentation of this card and the receipt. We will repair and return the repaired equipment to the customer within 2 working days of the receipt date.

Note: This warranty card must be attached when this product is returned to the factory for maintenance, otherwise free maintenance will not be accepted. Thank you for your cooperation!

Product Certification

Product Model: _____ Product No.: _____

Inspector: _____ Ex-factory date: _____

Salesperson: _____ Sold Date: _____

SHENZHEN ATTEN TECHNOLOGY CO., LTD.

- Soldering iron ● Soldering station ● Hot air rework station
- Multi-function maintenance system
- Regulated DC power supply ● Switching DC power supply
- Programmable power supply

SHENZHEN ATTEN TECHNOLOGY CO., LTD.

Add: Floor 8, Building 2, Senyang High-tech Park, 7 West Road
High-tech Park, Guangming New district, Shenzhen 518132, China

Tel: +86-755-2697 6387

Fax: +86-755-8602 1337

Web: www.atten.com.cn(CN)

www.atten.com(EN)

Email: sales@atten.com.cn

Engineer's partner

All Copyright Reserved
MADE IN CHINA

CBN029642(A)